



MAESTRO 8 / 12

120V PENDANTS

location:
DAMP

SPECIFICATIONS:

DESCRIPTION

Maestro's timeless globe-shaped blown glass is anything but standard with its angle cut bottom, allowing for interesting design applications, particularly when employed in multilight configurations.

LAMPING

Standard: 60W Medium-based 120V, lamp not included. Dimmable with standard incandescent dimmer (not included).

LED Filament: 8W Replaceable A19 LED Filament lamp, 120V, dimmable, 80+ CRI, 3000°K CCT, 800 lumens, 15,000 hours, lamp included.

DIFFUSER

Shade shall be of glass in various transcolor decors and angled bottom opening.

Maestro 8: 7.875" Dia. x 7.5" H

Maestro 12: 11.75" Dia. x 11.5" H

SUSPENSION

Cord-hung: 10' SVT-type cord, complete with 5" decorative sleeve at the socketholder. Jacket coordinates with metal finish. Plated stamped steel construction. Black, Bronze or Satin Nickel. See next page for multi light options.

MOUNTING

Installs directly to a 4" octagonal ceiling box. Suitable for sloped ceilings.

LABELS

UL or ETL Listed. Suitable for Damp Locations (interior use only).

Consult factory concerning lower wattage labeling for energy requirements.



SMOKE (MAESTRO8SM) & CLEAR (MAESTRO12CL)

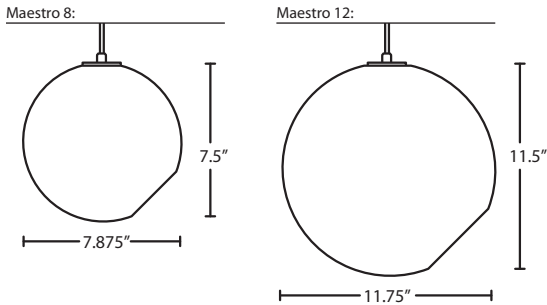

Project Information:

For ordering information, see next page

All dimensions provided are nominal.
Allowance must be made for dimensional tolerance in handcrafted glasses.

REV 5/22



ORDERING:

CONNECTION	GLASS OPTIONS	LAMP OPTIONS	METAL FINISH
Cord Fixtures	MAESTRO8CL 8" Clear	(blank) 60W A19 Incan	BK Black
1JC 1 Lt. Dome	MAESTRO8SM 8" Smoke	EDIL 8W LED Filament	BR Bronze
1JT 1 Lt. Flat			SN Satin Nickel
J For Multi light Canopy			

CONNECTION	GLASS OPTIONS	LAMP OPTIONS	METAL FINISH
Cord Fixtures	MAESTRO12CL 12" Clear	(blank) 60W A19 Incan	BK Black
1JC 1 Lt. Dome	MAESTRO12SM 12" Smoke	EDIL 8W LED Filament	BR Bronze
1JT 1 Lt. Flat			SN Satin Nickel
J For Multi light Canopy			

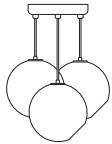

Multilight Canopies Available, see right

Ex. 1JT-MAESTRO8CL-SN
Maestro 8 Pendant, Clear Shade, Satin Nickel Finish

MULTIPOINT CANOPY OPTIONS FOR CORD PENDANTS

T33X 3 LIGHT ROUND CANOPY

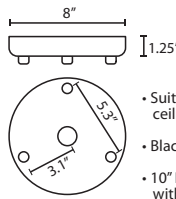

- Suitable for sloped ceilings
- Black, Bronze or Satin Nickel
- 10" Dia. shades MAX, with staggered heights
- * For larger diameter glasses, Stemhooks are required for spacing

T33XL 3 LIGHT LARGE ROUND CANOPY

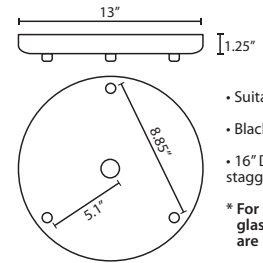

- Suitable for sloped ceilings
- Black, Bronze or Satin Nickel
- 16" Dia. shades MAX, with staggered heights
- * For larger diameter glasses, Stemhooks are required for spacing

T36X 6 LIGHT ROUND CANOPY

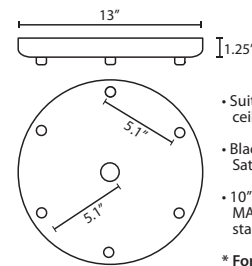

- Suitable for sloped ceilings
- Black, Bronze or Satin Nickel
- 10" Dia. shades MAX, with staggered heights
- * For larger diameter glasses, Stemhooks are required for spacing

T39X 9 LIGHT ROUND CANOPY

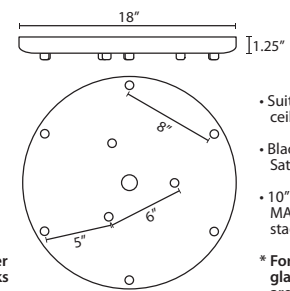

- Suitable for sloped ceilings
- Black, Bronze or Satin Nickel
- 10" Dia. shades MAX, with staggered heights
- * For larger diameter glasses, Stemhooks are required for spacing

T33V 3 LIGHT BAR CANOPY

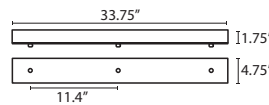

- Suitable for sloped ceilings
- Black, Bronze or Satin Nickel
- 20" Dia. shades MAX, with staggered heights
- * For larger diameter glasses, Stemhooks are required for spacing

T34V 4 LIGHT BAR CANOPY

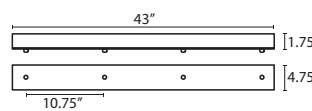

- Suitable for sloped ceilings
- Black, Bronze or Satin Nickel
- 20" Dia. shades MAX, with staggered heights
- * For larger diameter glasses, Stemhooks are required for spacing

T37V 7 LIGHT BAR CANOPY

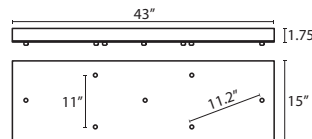

- Suitable for sloped ceilings
- Black, Bronze or Satin Nickel
- 20" Dia. shades MAX, with staggered heights
- * For larger diameter glasses, Stemhooks are required for spacing

PENDANT OPTIONS:

1JT / 1JC / J CORD-HUNG PENDANT

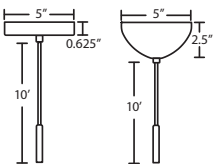

- Flat (1JT) or Dome (1JC) Canopy styles. Dome style allows adjustment without cutting cord.
- "J" option is pendant less canopy for multipoint canopy (options to the right)
- Suitable for sloped ceilings
- Cord: 10' SVT, 5" sleeve at socketholder
- Also available in 15'
- Black, Bronze or Satin Nickel
- Cord Sleeves are available in 18" lengths

ACCESSORIES:

LONGER CORD LENGTHS:

Longer cord length of 15' available. Add an "L" to the end of the item number, i.e. 1JC-169707-SN-L.

LOW WATTAGE LABELING:

Incandescent fixture supplied with 16 watt relamp label. Add an "LW" to the end of the item number, i.e. 1JC-169707-SN-LW.

CORD SLEEVES:

If concealing the cord is desired on a Cord-hung Pendant, order our 0.25" dia. metal sleeves. Each sleeve is 18" long and may be field cut.

- T118-BK** Black
- T118-BR** Bronze
- T118-SN** Satin Nickel

STEMHOOKS:

Suspension hooks allow cord drops to be placed wherever desired. Suitable for sloped ceilings or for greater multilight spacing

- T103BK** Black
- T103BR** Bronze
- T103SN** Satin Nickel

HOW TO ORDER A MULTILIGHT FIXTURE

Order your canopy with the selected 120V multi light pendants (indicated by "B" or "J" prefix) for the complete fixture:

Example: 1x T33XL-SN (3 Light Large Round Canopy)

- 1x J-MAESTRO8CL-SN (Maestro 8 Pendant in Clear)**
- 1x J-MAESTRO8SM-SN (Maestro 8 Pendant in Smoke)**
- 1x J-MAESTRO12CL-SN (Maestro 12 Pendant in Clear)**